



Water-Jacket Heated Hose Kit

309525G

EN

Part No. 245866

Includes parts needed to assemble heated hose system. Heated hose assembly and VISCON HP heater must be ordered separately.

See Technical Data on page 14 for Maximum Working Pressure and Temperature Rating information.



Important Safety Instructions

Read all warnings and instructions in this manual. Save these instructions.



Contents

Manual Conventions	2	Related Manuals	11
Heated Hose Components	4	Parts	12
Installation	7	Technical Data	14
Operation	10	Heated Hose Replacement Parts	15
Maintenance	11	Graco Standard Warranty	16
Troubleshooting	11	Graco Information	16

Manual Conventions

Warning

WARNING

A warning alerts you to possible serious injury or death if you do not follow instructions.

Symbols, such as fire and explosion (shown), alert you to a specific hazard and direct you to read the indicated hazard warnings (below).

Caution

CAUTION







A caution alerts you to possible equipment damage or destruction if you do not follow instructions.

Note

A note indicates additional helpful information.

WARNING

	<p>SKIN INJECTION HAZARD</p> <p>High-pressure fluid from gun, hose leaks, or ruptured components will pierce skin. This may look like just a cut, but it is a serious injury that can result in amputation. Get immediate surgical treatment.</p> <ul style="list-style-type: none"> Do not stop or deflect leaks with your hand, body, glove, or rag. Tighten all fluid connections before operating the equipment. Check hoses, tubes, and couplings daily. Replace worn or damaged parts immediately. High pressure hose cannot be recoupled; replace the entire hose.
	<p>FIRE AND EXPLOSION HAZARD</p> <ul style="list-style-type: none"> Solvent and paint fumes in work area can ignite or explode. To help prevent fire and explosion: Use equipment only in well ventilated area. Eliminate all ignition sources, such as pilot lights, cigarettes and plastic drop cloths (potential static arc). Do not plug or unplug power cords or turn lights on or off when flammable fumes are present. Keep the work area free of debris, including solvent, rags, and gasoline. Ground equipment and conductive objects. If there is static sparking or you feel an electric shock, stop operation immediately. Do not use equipment until you identify and correct the problem.

 WARNING	
	<p>ELECTRIC SHOCK HAZARD</p> <p>Improper grounding, wiring, or usage of the system can cause electric shock.</p> <ul style="list-style-type: none"> • All electrical wiring must be done by a qualified electrician and comply with all local codes and regulations. • Connect only to grounded power source. • Turn off and disconnect power at the main switch before disconnecting any cables and before servicing equipment.
	<p>EQUIPMENT MISUSE HAZARD</p> <p>Misuse can cause serious injury or death.</p> <ul style="list-style-type: none"> • For professional use only. • Use equipment only for its intended purpose. Call your Graco distributor for information. • Read manuals, warnings, tags, and labels before operating equipment. Follow instructions. • Check equipment daily. Repair or replace worn or damaged parts immediately. • Do not alter or modify equipment. Use only Graco parts and accessories. • Do not exceed the maximum working pressure or temperature rating of the lowest rated system component. See page 14 and the Technical Data for all system components. • Use fluids and solvents that are compatible with equipment wetted parts. See Technical Data in all equipment manuals. Read fluid and solvent manufacturer's warnings. • Route hoses and cables away from traffic areas, sharp edges, moving parts, and hot surfaces. • Comply with all applicable safety regulations.
	<p>BURN HAZARD</p> <p>This equipment is used with heated fluid, which can cause equipment surfaces to become very hot. To avoid severe burns:</p> <ul style="list-style-type: none"> • Do not touch hot fluid or equipment. • Allow equipment to cool completely before touching it. • Wear heat protective gloves and take special care if fluid temperature exceeds 110° F (43° C).
	<p>TOXIC FLUID OR FUMES HAZARD</p> <p>Toxic fluids or fumes can cause serious injury or death if splashed in the eyes or on skin, inhaled, or swallowed.</p> <ul style="list-style-type: none"> • Read Material Safety Data Sheets (MSDS) to know the specific hazards of the fluids you are using. • Store hazardous fluid in approved containers, and dispose of it according to applicable guidelines.
	<p>PERSONAL PROTECTIVE EQUIPMENT</p> <p>You must wear proper protective equipment when operating, servicing, or when in the operating area of the equipment to help protect you from serious injury, including eye injury; inhalation of toxic fumes; and hearing loss. This equipment includes but is not limited to:</p> <ul style="list-style-type: none"> • Protective eyewear • Gloves, clothing, and respirator as recommended by the fluid and solvent manufacturer • Hearing protection

Heated Hose Components

You need the following parts to install the heated hose system on the Xtreme Mix proportioner.

Heated Hose Kit 245866

The kit described in this manual, which includes all miscellaneous parts needed to assemble the system.

Heated Hose Assembly

Order separately a heated hose assembly that meets maximum pressure and hose diameter requirements. You can connect up to six 50 ft. (15.2 m) heated hose sections for a maximum total length of 300 ft. (91.4 m).

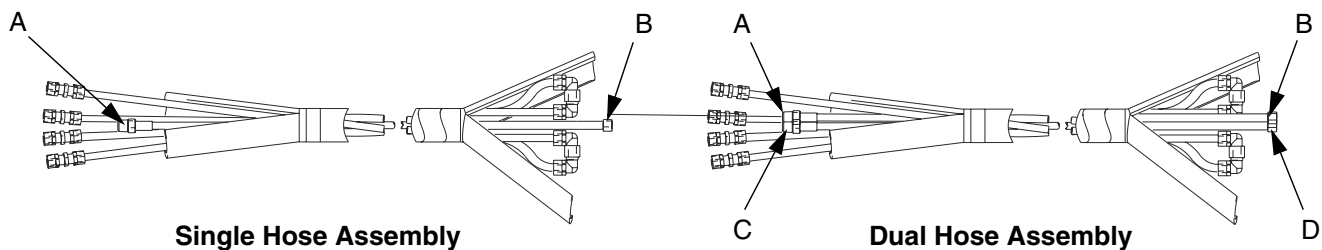

Single Hose Assemblies

Part No., Series	Maximum Pressure Rating <i>psi (MPa, bar)</i>	Hose Diameter <i>in. (mm)</i>	Thread A <i>npt(m)</i>	Thread B <i>npsm(f)</i>	Approvals
245840, C	5000 psi (34, 345)	1/4 (6.35)	1/4	1/4	
245841, C	7250 psi (50, 500)	1/4 (6.35)	1/4	1/4	
245842, C	5000 psi (34, 345)	3/8 (9.53)	3/8	3/8	
245843, C	7250 psi (50, 500)	3/8 (9.53)	3/8	3/8	
245844, C	5000 psi (34, 345)	1/2 (12.7)	1/2	1/2	
245845, C	7250 psi (50, 500)	1/2 (12.7)	1/2	1/2	

Dual Hose Assemblies

Part No., Series	Maximum Pressure Rating <i>psi (MPa, bar)</i>	Hose Diameter <i>in. (mm)</i>	Thread A <i>npt(m)</i>	Thread B <i>npsm(f)</i>	Thread C <i>npt(m)</i>	Thread D <i>npsm(f)</i>	Approvals
248118, C	7250 psi (50, 500)	1/2 (12.7)	1/2	1/2	1/2	1/2	
248119, C	7250 psi (50, 500)	3/8 (9.53)	3/8	3/8	3/8	3/8	
248120, C	7250 psi (50, 500)	A = 1/2 (12.7) B = 3/8 (9.53)	1/2	1/2	3/8	3/8	
248121, C	7250 psi (50, 500)	A = 3/8 (9.53) B = 1/4 (6.35)	3/8	3/8	1/4	1/4	

Fluid Heater

Order separately a VISCON HP heater that meets local electrical and hazardous location requirements.

Hazardous Location Heaters

Part No.	Series	VAC (50/60 Hz single phase) / Watts / Amps	Approvals
245848	A	120 / 2300 / 19.2	See heater manual 309524 for approvals.
245863	A	240 / 4000 / 16.7	
245864	A	480 / 4000 / 8.30	
245862	A	200 / 4000 / 20.0	
246254	A	380 / 4000 / 10.5	

Non-hazardous Location Heaters

Model No.	Series	VAC (50/60 Hz single phase) / Watts / Amps	Approvals
245867	A	120 / 2300 / 19.2	See heater manual 309524 for approvals.
245868	A	200 / 4000 / 20.0	
245869	A	240 / 4000 / 16.7	
245870	A	480 / 4000 / 8.30	
246276	A	380 / 4000 / 10.5	



Lined page for notes with horizontal ruling lines.

Installation

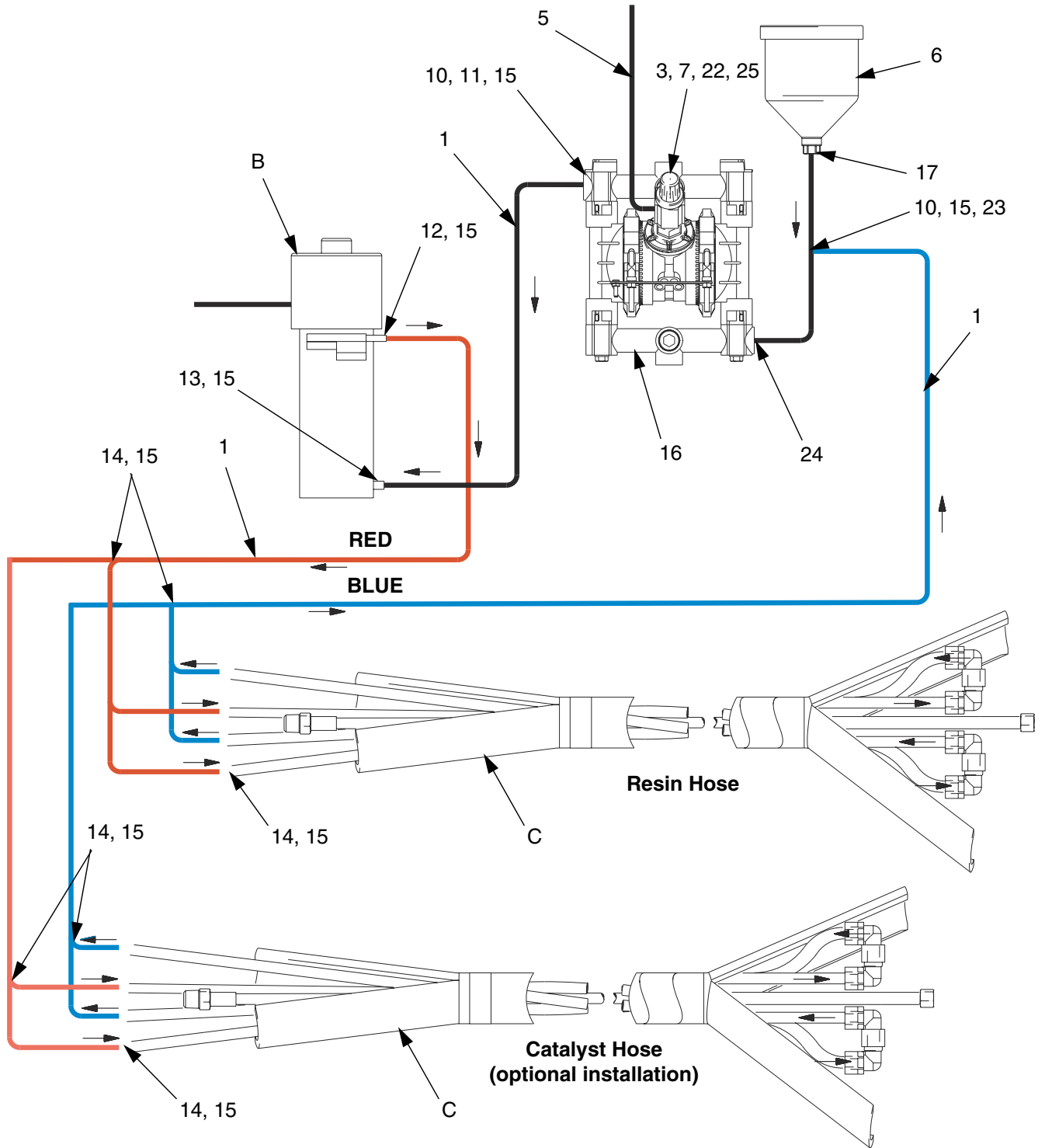



FIG. 1: Fluid and Air Line Connection Schematic

Installing the Kit

Refer to FIG. 1 and FIG. 2

1. Mount pump (16) on the Xtreme Mix cart (D) using the bracket (21), lockwashers (4), and nuts (2).
2. Mount VISCON HP heater (B-ordered separately) on the cart using screws and lockwashers (A) supplied with the heater, and the bracket (8), screws (9), lockwashers (19), and nuts (20) supplied with the kit.
3. Connect nipple (22) and air regulator (7) to Husky 716 pump. Connect 100 psi (0.7MPa, 7 bar) air supply to the air regulator using air tubing (5), and air fitting (3). Refer to Husky 716 manual if needed.

 The air regulator (7) controls pump (16) pressure.

 **WARNING**







All wiring must be done by an electrician. See warnings, page 2.

4. Wire VISCON HP heater (B) to your voltage supply. Follow wiring procedure in the VISCON HP manual.
5. Connect elbow (24), fitting (23), o-ring (17), and reservoir tank (6) to Husky 716 pump (16). On other side of pump, install bushing (11) and tube fitting (10).
6. Connect tube fittings (12, 13) to the VISCON HP heater (B).

7. Interconnect reservoir tank (6), Husky 716 pump (16), VISCON HP heater (B), and heated hose (C-FIG. 1), using tubing (1), tube inserts (15) and fittings (10, 12, 13, 14) as described below.

 To ensure a leak-proof seal, use PTFE tape on all pipe thread connections.

- a. Using tubing cutter (19), cut tubing (1) squarely to desired lengths.
- b. Insert tube inserts (15) in tubing (1) ends to avoid leakage.
- c. Insert tubing (1) through the back of the nut in each of the plastic fittings (10, 12, 13, 14) until the tube stops. Tighten the nut hand tight, then tighten it 1-1/2 to 2 turns with a wrench.

 Fitting nuts may need retightening as the system reaches normal operating temperatures.

Connecting Additional Hose Lengths

Up to six 50 ft. (15.2 m) sections of heated hose can be attached for a maximum total length of 300 ft. (91.4 m).

1. Remove plastic u-turn fittings at the end of the heated hose assembly. See FIG. 1.
2. Connect the next length of hose, using union fittings supplied with the hose. Follow fitting assembly procedure in steps 7a-7c, above.
3. Tubes are color coded. Connect like colors.

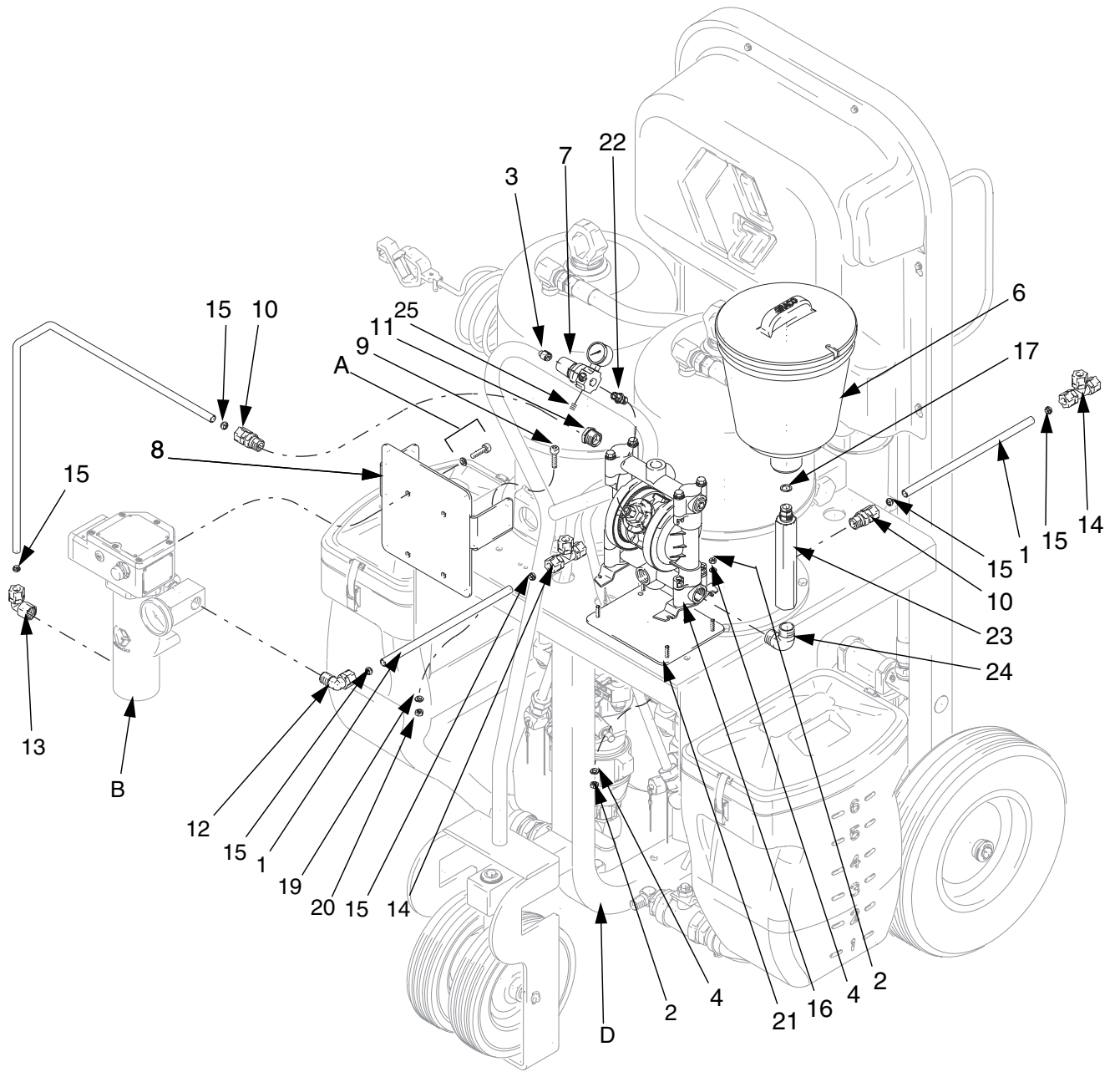





FIG. 2: Kit Installation

Operation

Refer to FIG. 2

 **WARNING**





Read the warnings, page 2, before operating the equipment.

1. Select fluid to use for heating circulation.
 - If ambient temperatures (storage or operating) are below 40° F (4.4° C), a 50% water and 50% antifreeze mixture is recommended.
 - If ambient temperatures are above 40° F (4.4° C), water alone is okay.

 Detailed diaphragm pump operating instructions are in Husky 716 manual.

2. Pour heating circulation fluid into the reservoir tank (6), increase air regulator (7) pressure, and cycle the pump (16). Continue to pour fluid into tank until all air is purged.

 Each 50 ft. (15.2 m) heated hose section holds approximately 1.25 gal. (4.7 liters) of fluid.

3. Fill reservoir tank (6) about half full. Do not overfill; fluid needs room to expand as the hose heats.
4. Set the flow rate of the circulation fluid to 2 gpm (7.6 lpm) by adjusting the pump's air regulator (7) until the pump cycles at 50 cycles/min. Do not use a higher flow rate as doing so will decrease system performance and pump life. Never exceed the hose's 95 psi (0.6 MPa, 6.6 bar) maximum working pressure rating.
5. Adjust the heater thermostat to the desired hose temperature. The setting should be about 10° F (6° C) higher than the desired paint temperature. Never exceed the hose's 180° F (82° C) maximum temperature rating.

 If the hose is not being used for more than one hour, shut off VISCON HP heater and Husky 716 pump to lengthen heater life.

Maintenance

- Check reservoir tank fluid level daily. Add fluid as needed.
- Follow pump maintenance instructions in Husky 716 manual.
- Follow heater maintenance instructions in VISCON HP manual.

Troubleshooting

Problem	Cause	Solution
Fluid leaking out of reservoir tank when pump is turned off.	Tank overfilled.	Do not fill reservoir tank more than half full.
Fluid fittings leaking.	Loose fittings.	Tighten fittings after system reaches desired temperature.
Hose not heating to desired temperature.	Diaphragm flow rate set too high.	Decrease diaphragm pump flow rate.
	Problem with VISCON HP heater.	See troubleshooting in VISCON HP heater manual.
Husky 716 pump not operating correctly.		See troubleshooting in Husky 716 pump manual.

Related Manuals

Refer to the following manuals for detailed equipment information.

Component Manuals

Manual	Description
309524	VISCON HP Heater
308981	Husky 716 Diaphragm Pump
309615	Heater Bracket Kit

This manual available in following languages:

Manual	Language	Manual	Language
309525	English	309562	Swedish
309559	French	309588	Chinese
309560	Spanish	309589	Korean
309561	German	309590	Japanese

Parts

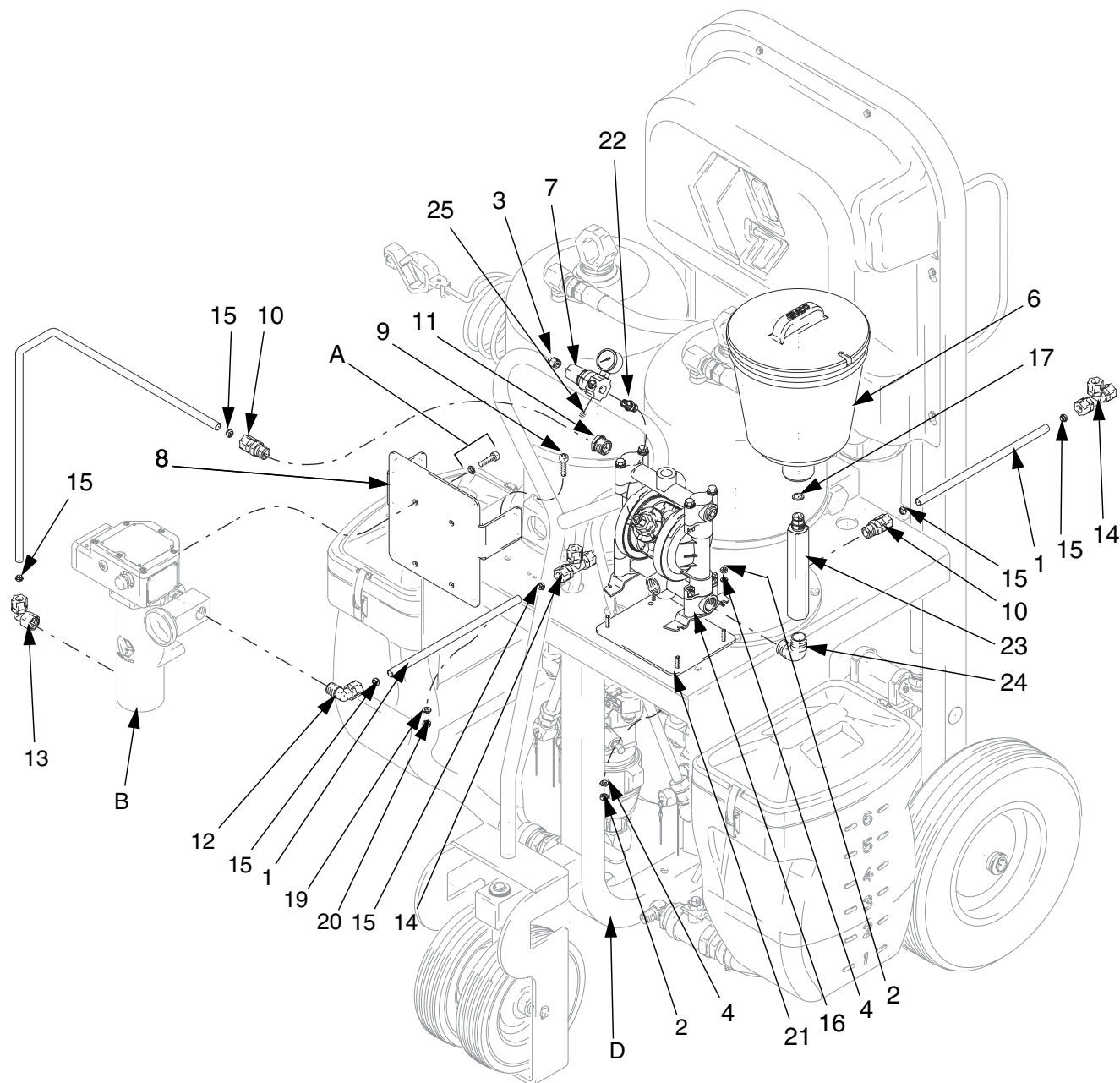

Ref. No.	Part No.	Description	Qty.	Ref. No.	Part No.	Description	Qty.
1*	---	TUBING; polyurethane; 1/2" (13 mm) OD; 10 ft. (3 m)		14**	117425	TEE; 1/2" (13 mm) OD tube	2
2	100015	NUT; 1/4-20 UNC-2B	7	15**	117426	TUBE INSERT; 1/2" (13 mm) OD tube	6
3	C19391	ELBOW; 1/4 nptm x 1/4" (6.35 mm) OD tube	2	16	D53266	716 HUSKY PUMP	1
4	100016	LOCKWASHER	7	17	104938	O-RING; fluoroelastomer	1
5*	---	TUBING; nylon; 1/4" (6.35 mm) OD; 6 ft. (1.8 m)		19	106115	LOCKWASHER	2
6	188787	RESERVOIR TANK; 1.5 gal. (5.7 liter)	1	20	100131	NUT; 3/8-16	2
7	110147	AIR REGULATOR; 1/4 npt	1	21	15B337	BRACKET (pump)	1
8	15B336	BRACKET (heater)	1	22	156971	NIPPLE; 1/4 npt	1
9	110141	CAP SCREW; 3/8-16 x 1-1/2 in. (13 mm)	2	23	15B338	FITTING	1
10	116316	FITTING; 1/2-14 npt x 1/2" (13 mm) OD tube	2	24	108307	ELBOW; 3/4 npt(m)	1
11	117326	BUSHING; 3/4 npt(m) x 1/2 npt(f)	1	25	100139	PLUG, pipe	1
12	117423	ELBOW; 1/2 npt(m) x 1/2" (13 mm) OD tube	1				
13	117424	ELBOW; 1/2 npt(f) x 1/2" (13 mm) OD tube	1				

* Not available from Graco.

** If you are plumbing resin and catalyst hoses in parallel, purchase 4 additional tees (117425) and 12 additional inserts (117426).

Technical Data

Maximum Working Pressure

High Pressure Fluid Hose	See Heated Hose Assembly table, page 4
Heated Fluid Circulation Components	95 psi (0.6 MPa, 6.6 bar)

Maximum Temperature Rating 180° F (82° C)

Wetted Parts

High Pressure Fluid Hose	Nylon, Zinc-Plated Carbon Steel
Heated Fluid Circulation Tubes	Nylon
Heated Fluid Circulation Fittings	Polypropylene, Aluminum, Brass, Zinc-Plated Carbon Steel

Reservoir Tank Low Density Polyethylene

Heated Hose Dry Weight 31 lb (14.1 kg)

Heated Hose Replacement Parts

Order the quantity required for your hose.

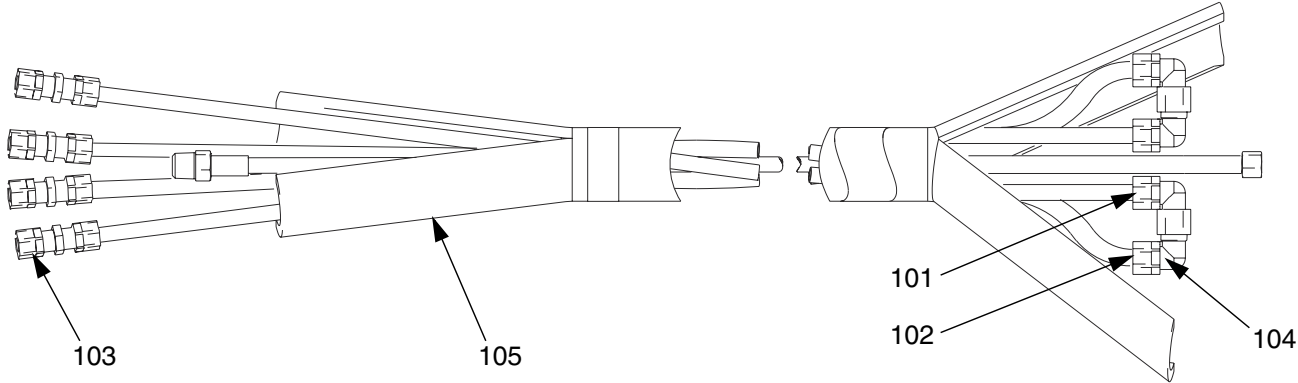

Ref. No.	Part No.	Description
101	117423	ELBOW; 1/2 npt(m) x 1/2" (13 mm) OD tube
102	117424	ELBOW; 1/2 npt(f) x 1/2" (13 mm) OD tube

Ref. No.	Part No.	Description
103	117461	FITTING; 1/2" (13 mm) OD tube
104	117426	TUBE INSERT; 1/2" (13 mm) OD tube
105	246456	HOSE COVER, protective; 50 ft. (15 m) long

Accessory Scuff Jacket

Use to cover and protect heated hose.
85 ft. (25.9 m)

Graco Standard Warranty

Graco warrants all equipment referenced in this document which is manufactured by Graco and bearing its name to be free from defects in material and workmanship on the date of sale to the original purchaser for use. With the exception of any special, extended, or limited warranty published by Graco, Graco will, for a period of twelve months from the date of sale, repair or replace any part of the equipment determined by Graco to be defective. This warranty applies only when the equipment is installed, operated and maintained in accordance with Graco's written recommendations.

This warranty does not cover, and Graco shall not be liable for general wear and tear, or any malfunction, damage or wear caused by faulty installation, misapplication, abrasion, corrosion, inadequate or improper maintenance, negligence, accident, tampering, or substitution of non-Graco component parts. Nor shall Graco be liable for malfunction, damage or wear caused by the incompatibility of Graco equipment with structures, accessories, equipment or materials not supplied by Graco, or the improper design, manufacture, installation, operation or maintenance of structures, accessories, equipment or materials not supplied by Graco.

This warranty is conditioned upon the prepaid return of the equipment claimed to be defective to an authorized Graco distributor for verification of the claimed defect. If the claimed defect is verified, Graco will repair or replace free of charge any defective parts. The equipment will be returned to the original purchaser transportation prepaid. If inspection of the equipment does not disclose any defect in material or workmanship, repairs will be made at a reasonable charge, which charges may include the costs of parts, labor, and transportation.

THIS WARRANTY IS EXCLUSIVE, AND IS IN LIEU OF ANY OTHER WARRANTIES, EXPRESS OR IMPLIED, INCLUDING BUT NOT LIMITED TO WARRANTY OF MERCHANTABILITY OR WARRANTY OF FITNESS FOR A PARTICULAR PURPOSE.

Graco's sole obligation and buyer's sole remedy for any breach of warranty shall be as set forth above. The buyer agrees that no other remedy (including, but not limited to, incidental or consequential damages for lost profits, lost sales, injury to person or property, or any other incidental or consequential loss) shall be available. Any action for breach of warranty must be brought within two (2) years of the date of sale.

GRACO MAKES NO WARRANTY, AND DISCLAIMS ALL IMPLIED WARRANTIES OF MERCHANTABILITY AND FITNESS FOR A PARTICULAR PURPOSE, IN CONNECTION WITH ACCESSORIES, EQUIPMENT, MATERIALS OR COMPONENTS SOLD BUT NOT MANUFACTURED BY GRACO. These items sold, but not manufactured by Graco (such as electric motors, switches, hose, etc.), are subject to the warranty, if any, of their manufacturer. Graco will provide purchaser with reasonable assistance in making any claim for breach of these warranties.

In no event will Graco be liable for indirect, incidental, special or consequential damages resulting from Graco supplying equipment hereunder, or the furnishing, performance, or use of any products or other goods sold hereto, whether due to a breach of contract, breach of warranty, the negligence of Graco, or otherwise.

FOR GRACO CANADA CUSTOMERS

The Parties acknowledge that they have required that the present document, as well as all documents, notices and legal proceedings entered into, given or instituted pursuant hereto or relating directly or indirectly hereto, be drawn up in English. Les parties reconnaissent avoir convenu que la rédaction du présente document sera en Anglais, ainsi que tous documents, avis et procédures judiciaires exécutés, donnés ou intentés, à la suite de ou en rapport, directement ou indirectement, avec les procédures concernées.

Graco Information

For the latest information about Graco products, visit www.graco.com.

TO PLACE AN ORDER, contact your Graco distributor or call to identify the nearest distributor.

Phone: 612-623-6921 **or Toll Free:** 1-800-328-0211, **Fax:** 612-378-3505

All written and visual data contained in this document reflects the latest product information available at the time of publication. Graco reserves the right to make changes at any time without notice.

Original instructions. This manual contains English. MM 309525

Graco Headquarters: Minneapolis

International Offices: Belgium, China, Japan, Korea

GRACO INC. AND SUBSIDIARIES • P.O. BOX 1441 • MINNEAPOLIS MN 55440-1441 • USA

Copyright 2002, Graco Inc. All Graco manufacturing locations are registered to ISO 9001.

www.graco.com

Revised 10/2011